

# ARCHITECTURAL MOULDINGS RANGE



PROVINCIAL CLADDING  
DECORATE YOUR INVESTMENT

## **PROVINCIAL CLADDING DECORATIVE PRODUCTS**

Provincial Cladding supply a complete range of exterior decorative architectural mouldings for residential and commercial builders, architects, home owners and DIY renovators. Our lightweight design, durability, precision shape profile and aesthetic appeal make them the choice for astute designers.

Choose from our wide range of architraves, window sills, stringers, plinths and parapets to achieve virtually any style or effect you desire from Georgian, French Provincial, Edwardian or Traditional Victorian to Tudor, Federation, Romanesque and even Art Deco.

We offer you a wide range of other decorative lightweight products including pier and fence cappings, corbels, keystones, plaques, embellishments, quoins, columns, pilasters and profiled arches and curves that are made to order to suit specific requirements.

On your next project whether it be residential or commercial, you can be sure that Provincial Cladding has the specific architectural lightweight product to finish your project to perfection.





## **CONTENTS**

<b>WINDOW ARCHITRAVES</b>	<b>PG 3-4</b>
<b>WINDOW SILLS</b>	<b>PG 5</b>
<b>PARAPETS</b>	<b>PG 6-8</b>
<b>PLINTHS</b>	<b>PG 9</b>
<b>STRINGERS</b>	<b>PG 10-11</b>
<b>FLAT BANDS</b>	<b>PG 12</b>
<b>BANDS</b>	<b>PG 13</b>
<b>PIER CAPPINGS</b>	<b>PG 14-15</b>
<b>QUOINS</b>	<b>PG 16</b>

This Information is presented to provide an introduction to the product range offered by Provincial Cladding. Where dimensions are shown, they are intended to be a guide only and may be subject to change without given notice. For critical applications please confirm actual dimensions with your Provincial Cladding sales representative.



## WA-101

Side Profile



3 Dimensional Visualisation

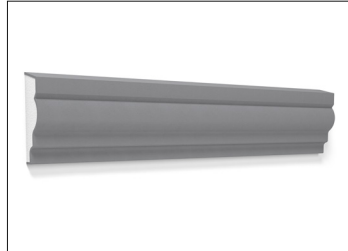

Dimensions:  
**75mm(h) x 25mm(w)**

## WA-102

Side Profile

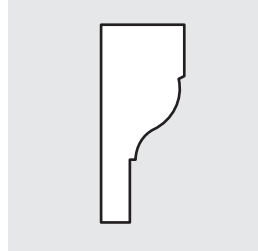

3 Dimensional Visualisation

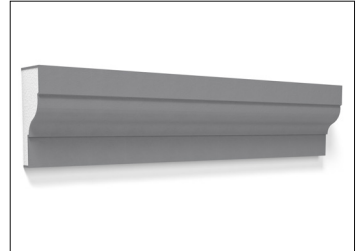

Dimensions:  
**80mm(h) x 35mm(w)**

## WA-103

Side Profile

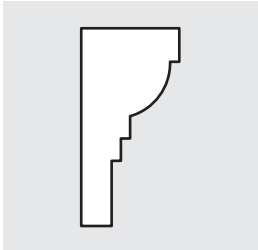

3 Dimensional Visualisation

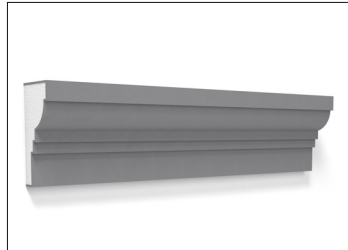

Dimensions:  
**90mm(h) x 45mm(w)**

## WA-104

Side Profile

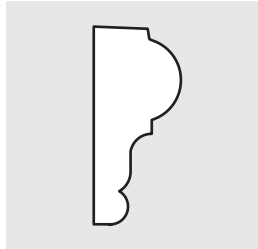

3 Dimensional Visualisation

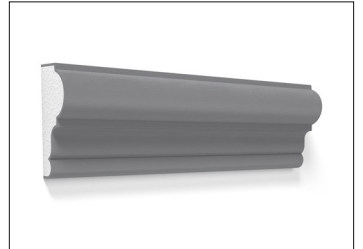

Dimensions:  
**90mm(h) x 40mm(w)**

## WA-105

Side Profile

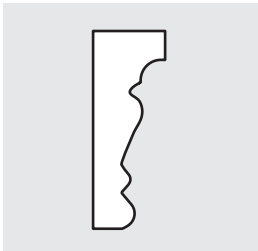

3 Dimensional Visualisation

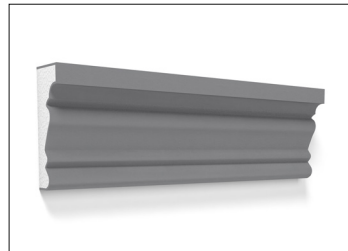

Dimensions:  
**95mm(h) x 35mm(w)**

## WA-106

Side Profile

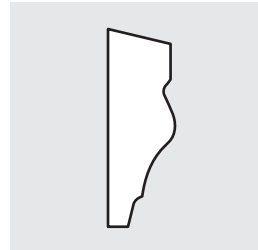

3 Dimensional Visualisation

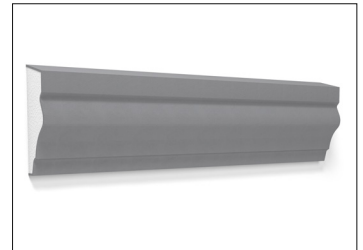

Dimensions:  
**95mm(h) x 35mm(w)**

## WA-107

Side Profile

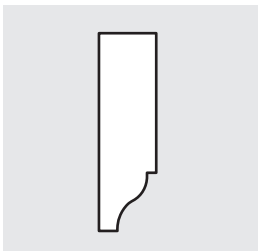

3 Dimensional Visualisation



Dimensions:  
**100mm(h) x 30mm(w)**

## WA-108

Side Profile

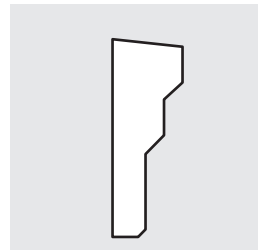

3 Dimensional Visualisation

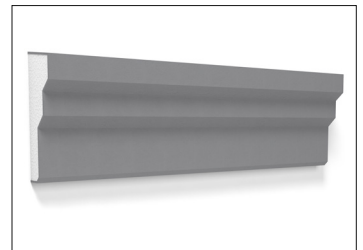

Dimensions:  
**110mm(h) x 40mm(w)**





# WINDOW ARCHITRAVES

## WA-109

Side Profile



3 Dimensional Visualisation

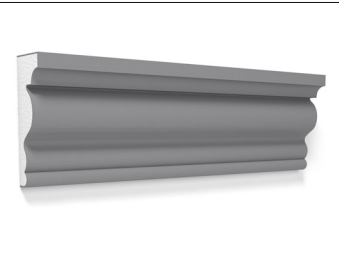

Dimensions:  
**115mm(h) x 40mm(w)**

## WA-110

Side Profile



3 Dimensional Visualisation

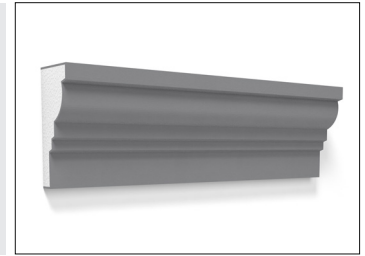

Dimensions:  
**115mm(h) x 40mm(w)**

## WA-111

Side Profile



3 Dimensional Visualisation

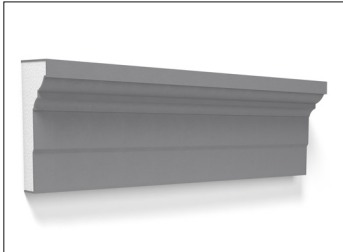

Dimensions:  
**120mm(h) x 55mm(w)**

## WA-112

Side Profile



3 Dimensional Visualisation

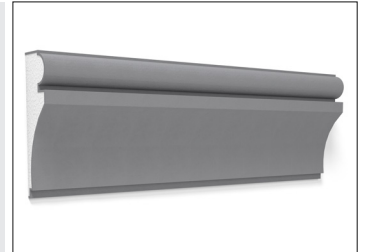

Dimensions:  
**125mm(h) x 40mm(w)**

## WA-113

Side Profile



3 Dimensional Visualisation

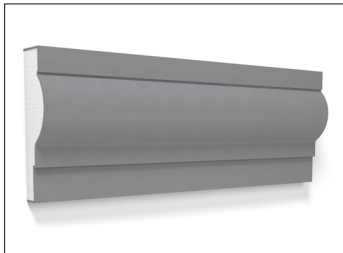

Dimensions:  
**135mm(h) x 40mm(w)**

## WA-114

Side Profile



3 Dimensional Visualisation

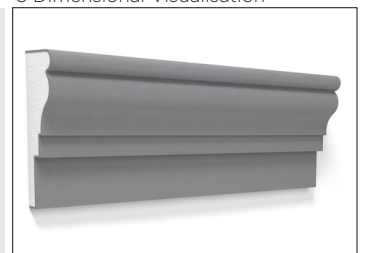

Dimensions:  
**140mm(h) x 50mm(w)**

## WA-115

Side Profile



3 Dimensional Visualisation



Dimensions:  
**150mm(h) x 65mm(w)**

## WA-116

Side Profile



3 Dimensional Visualisation

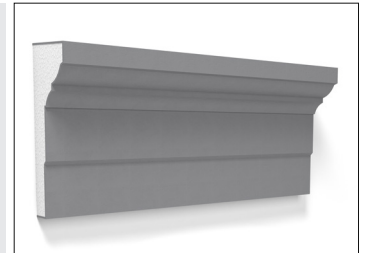

Dimensions:  
**165mm(h) x 65mm(w)**



## WS-201

Side Profile



3 Dimensional Visualisation

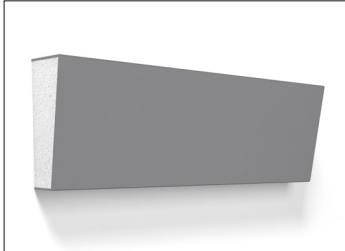

Dimensions:  
125mm(h) x 60mm(w)

## WS-201R

Side Profile

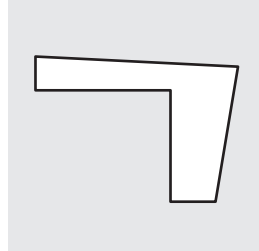

3 Dimensional Visualisation

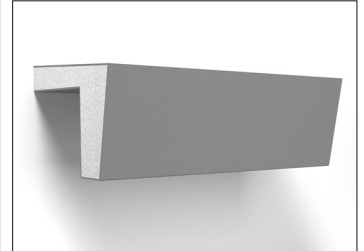

Dimensions:  
135mm(h) x 180mm(w)

## WS-202

Side Profile

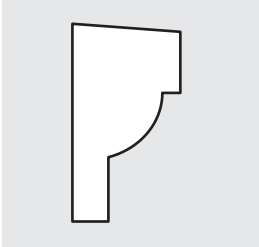

3 Dimensional Visualisation

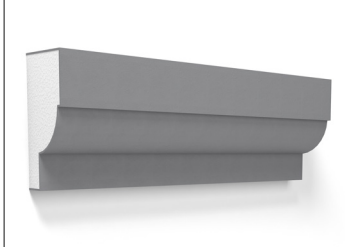

Dimensions:  
130mm(h) x 70mm(w)

## WS-202R

Side Profile

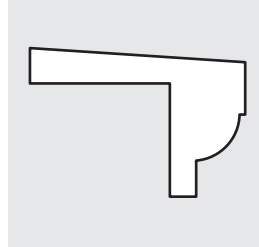

3 Dimensional Visualisation

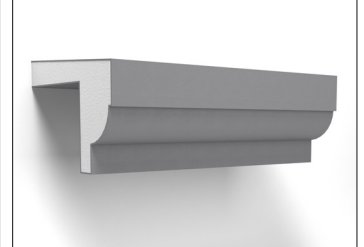

Dimensions:  
140mm(h) x 190mm(w)

## WS-203

Side Profile

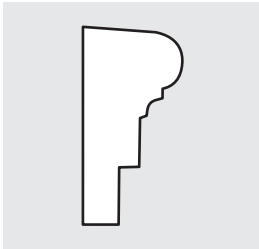

3 Dimensional Visualisation



Dimensions:  
135mm(h) x 70mm(w)

## WS-203R

Side Profile

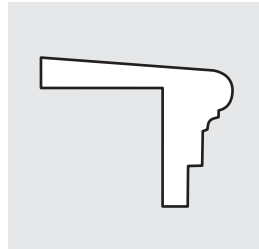

3 Dimensional Visualisation

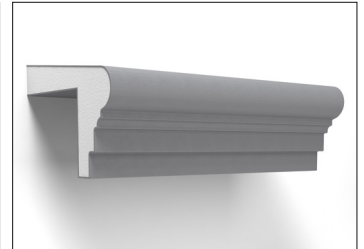

Dimensions:  
145mm(h) x 190mm(w)

## WS-204

Side Profile

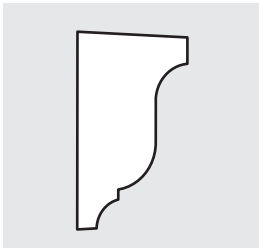

3 Dimensional Visualisation

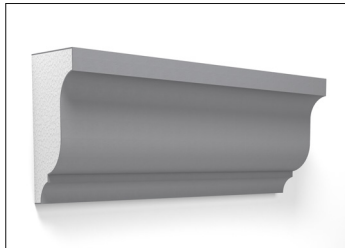

Dimensions:  
125mm(h) x 70mm(w)

## WS-205

Side Profile

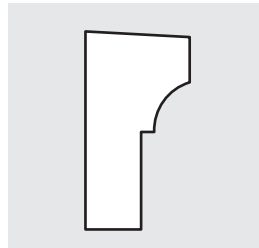

3 Dimensional Visualisation

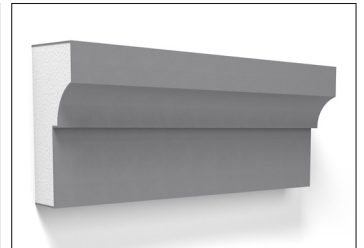

Dimensions:  
160mm(h) x 85mm(w)



# PARAPETS

## PM-301

Side Profile

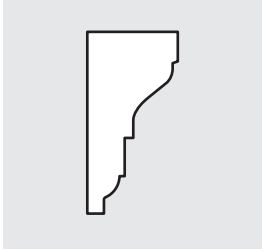

3 Dimensional Visualisation



Dimensions:  
**130mm(h) x 65mm(w)**

## PM-302

Side Profile

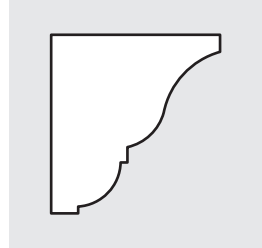

3 Dimensional Visualisation



Dimensions:  
**130mm(h) x 125mm(w)**

## PM-303

Side Profile

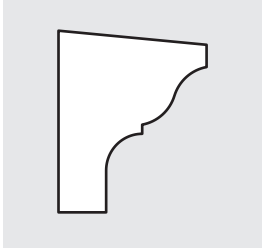

3 Dimensional Visualisation

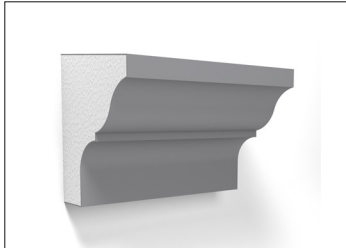

Dimensions:  
**140mm(h) x 115mm(w)**

## PM-304

Side Profile

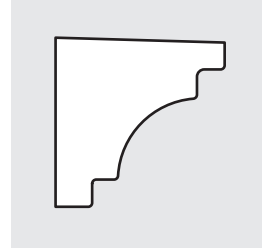

3 Dimensional Visualisation

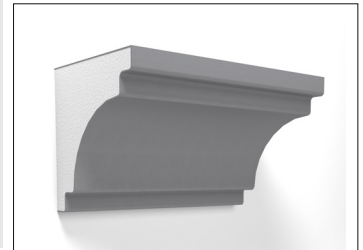

Dimensions:  
**150mm(h) x 150mm(w)**

## PM-305

Side Profile

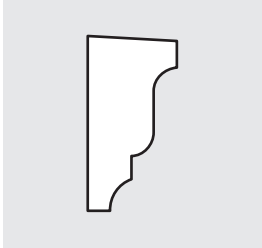

3 Dimensional Visualisation

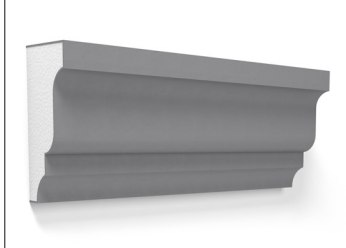

Dimensions:  
**155mm(h) x 80mm(w)**

## PM-306

Side Profile

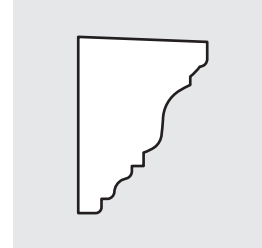

3 Dimensional Visualisation

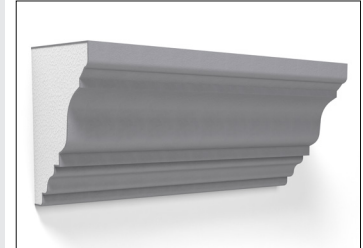

Dimensions:  
**170mm(h) x 125mm(w)**

## PM-307

Side Profile



3 Dimensional Visualisation

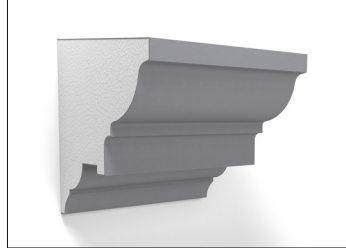

Dimensions:  
**170mm(h) x 165mm(w)**

## PM-308

Side Profile



3 Dimensional Visualisation

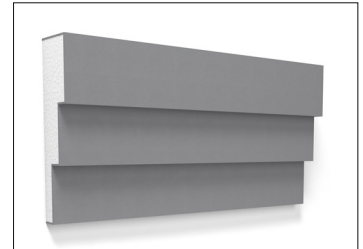

Dimensions:  
**185mm(h) x 50mm(w)**

## PM-309

Side Profile

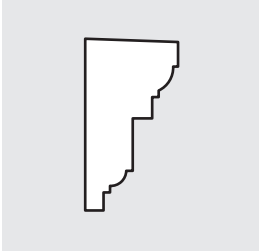

3 Dimensional Visualisation



Dimensions:  
185mm(h) x 100mm(w)

## PM-310

Side Profile

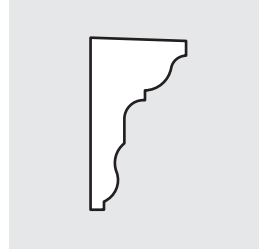

3 Dimensional Visualisation

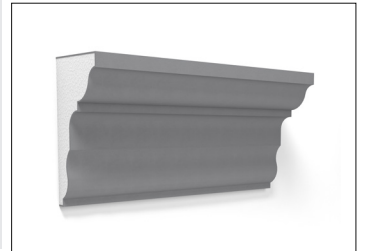

Dimensions:  
185mm(h) x 105mm(w)

## PM-311

Side Profile

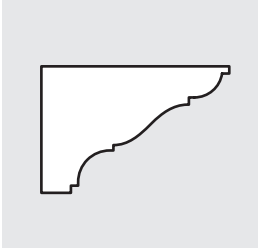

3 Dimensional Visualisation

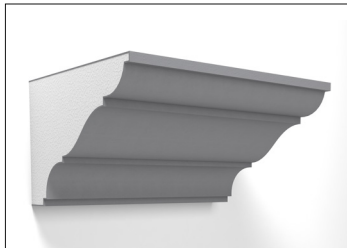

Dimensions:  
190mm(h) x 280mm(w)

## PM-312

Side Profile

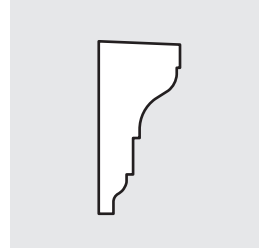

3 Dimensional Visualisation



Dimensions:  
210mm(h) x 100mm(w)

## PM-313

Side Profile

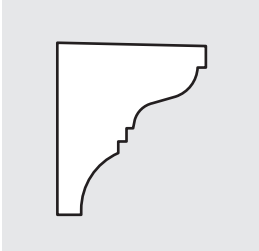

3 Dimensional Visualisation

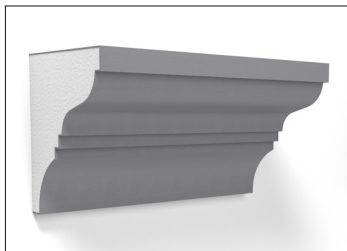

Dimensions:  
210mm(h) x 180mm(w)

## PM-314

Side Profile

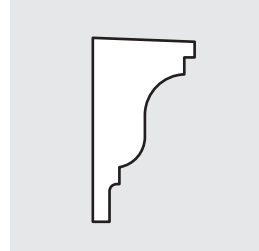

3 Dimensional Visualisation

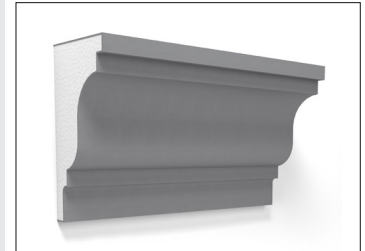

Dimensions:  
220mm(h) x 125mm(w)

## PM-315

Side Profile

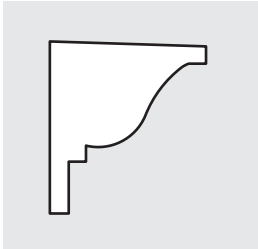

3 Dimensional Visualisation

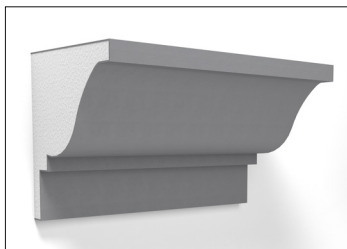

Dimensions:  
220mm(h) x 200mm(w)

## PM-316

Side Profile

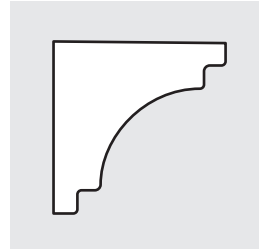

3 Dimensional Visualisation

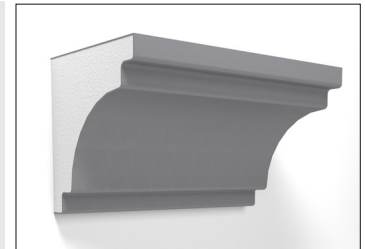

Dimensions:  
220mm(h) x 220mm(w)



# PARAPETS

## PM-317

Side Profile

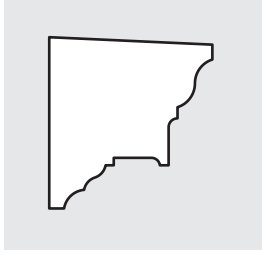

3 Dimensional Visualisation

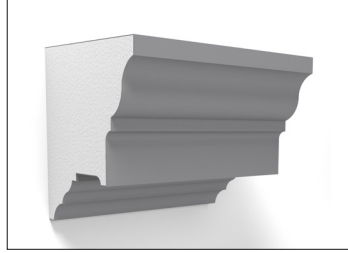

Dimensions:  
235mm(h) x 220mm(w)

## PM-318

Side Profile

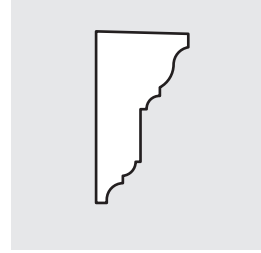

3 Dimensional Visualisation

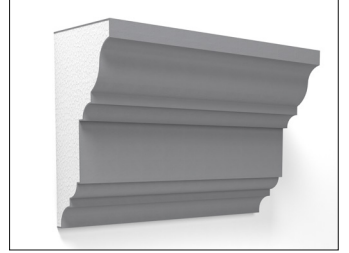

Dimensions:  
260mm(h) x 140mm(w)

## PM-319

Side Profile

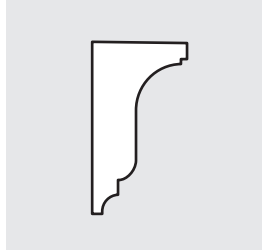

3 Dimensional Visualisation

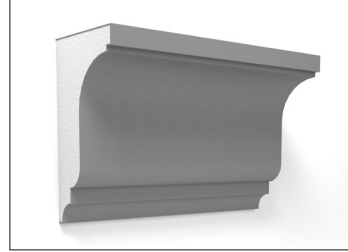

Dimensions:  
260mm(h) x 240mm(w)

## PM-320

Side Profile

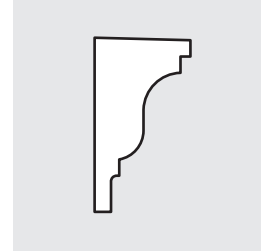

3 Dimensional Visualisation

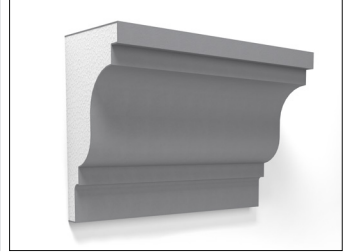

Dimensions:  
270mm(h) x 150mm(w)

## PM-321

Side Profile

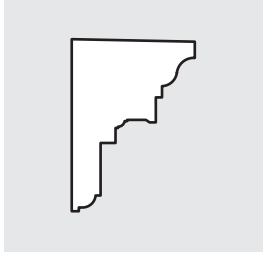

3 Dimensional Visualisation

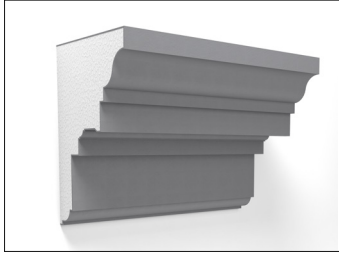

Dimensions:  
270mm(h) x 195mm(w)

## PM-322

Side Profile

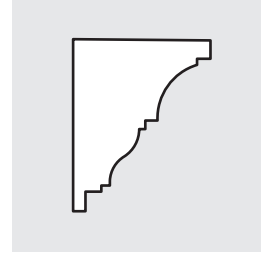

3 Dimensional Visualisation

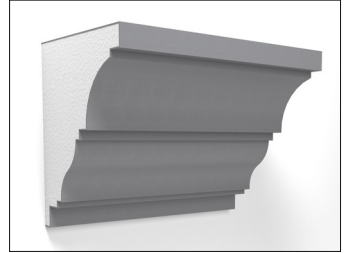

Dimensions:  
270mm(h) x 220mm(w)

## PM-323

Side Profile

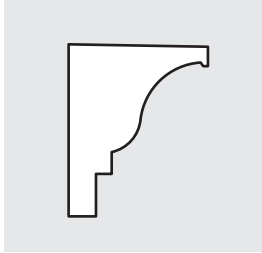

3 Dimensional Visualisation

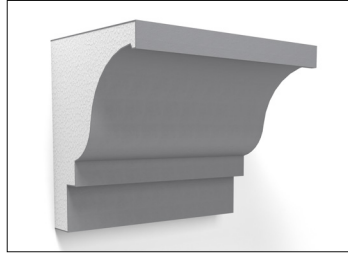

Dimensions:  
320mm(h) x 260mm(w)

## PM-324

Side Profile

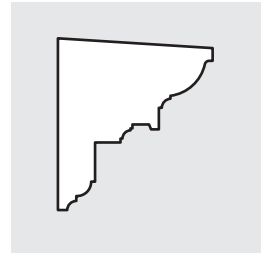

3 Dimensional Visualisation

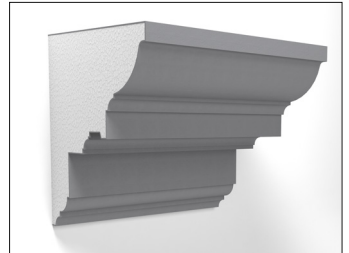

Dimensions:  
330mm(h) x 295mm(w)



## PL-701

Side Profile

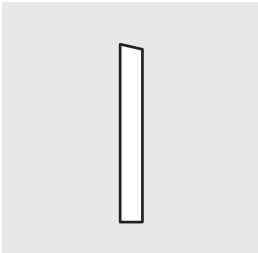

3 Dimensional Visualisation

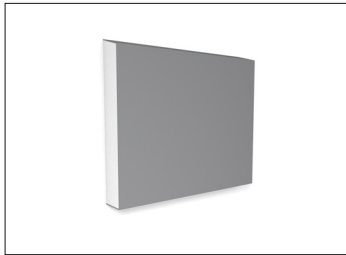

Dimensions:  
**400mm(h) x 55mm(w)**

## PL-702

Side Profile

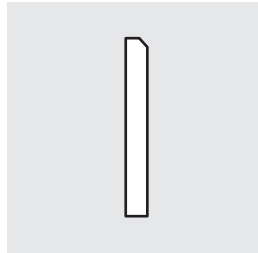

3 Dimensional Visualisation

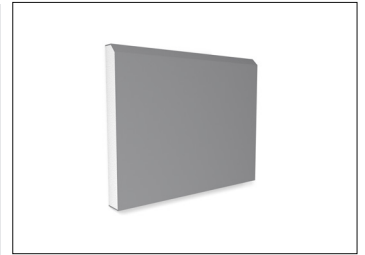

Dimensions:  
**300mm(h) x 40mm(w)**

## PL-703

Side Profile

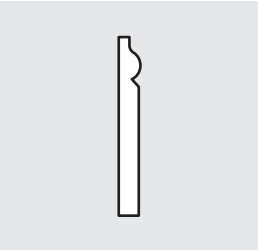

3 Dimensional Visualisation



Dimensions:  
**300mm(h) x 40mm(w)**

## PL-704

Side Profile

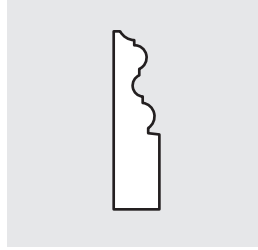

3 Dimensional Visualisation

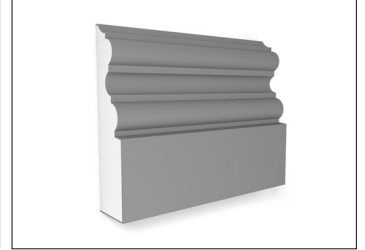

Dimensions:  
**300mm(h) x 80mm(w)**

## PL-705

Side Profile

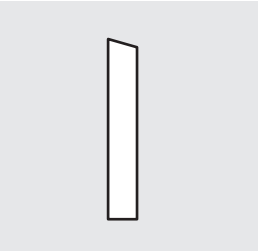

3 Dimensional Visualisation



Dimensions:  
**300mm(h) x 40mm(w)**

## PL-706

Side Profile

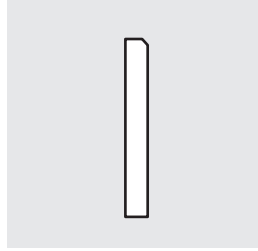

3 Dimensional Visualisation



Dimensions:  
**400mm(h) x 55mm(w)**





# STRINGERS

## SM-401

Side Profile

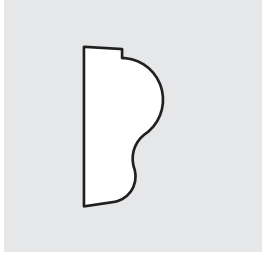

3 Dimensional Visualisation

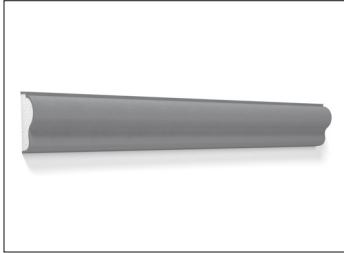

Dimensions:  
50mm(h) x 25mm(w)

## SM-402

Side Profile

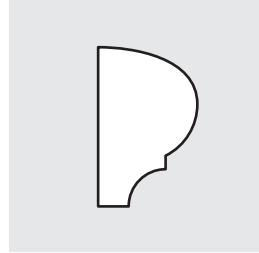

3 Dimensional Visualisation

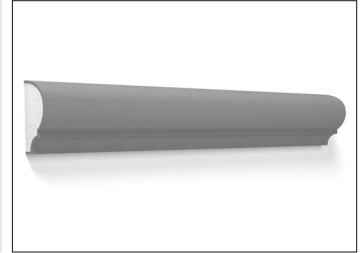

Dimensions:  
60mm(h) x 35mm(w)

## SM-403

Side Profile

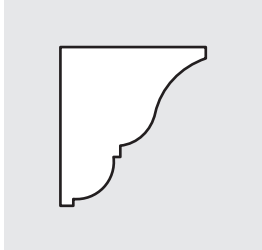

3 Dimensional Visualisation

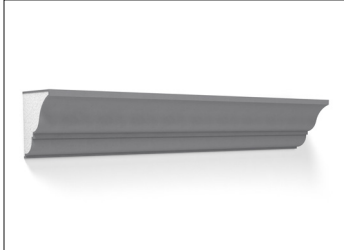

Dimensions:  
60mm(h) x 55mm(w)

## SM-404

Side Profile



3 Dimensional Visualisation

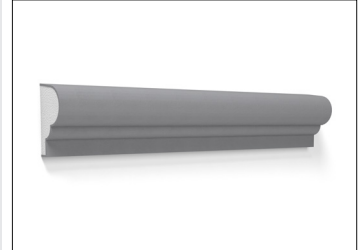

Dimensions:  
65mm(h) x 40mm(w)

## SM-405

Side Profile

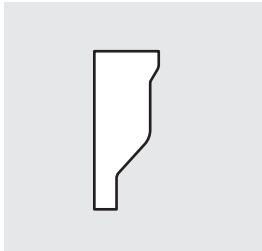

3 Dimensional Visualisation

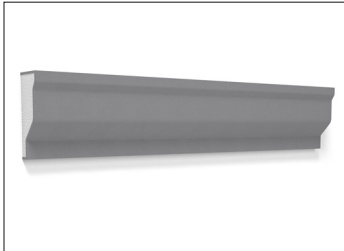

Dimensions:  
70mm(h) x 30mm(w)

## SM-406

Side Profile

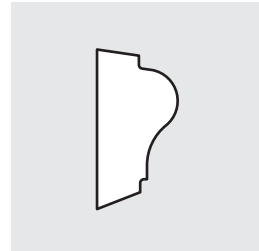

3 Dimensional Visualisation

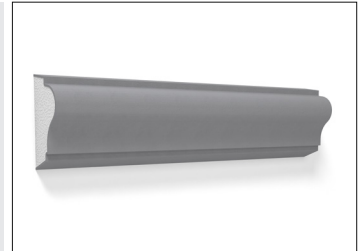

Dimensions:  
90mm(h) x 45mm(w)

## SM-407

Side Profile

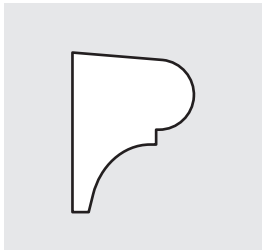

3 Dimensional Visualisation

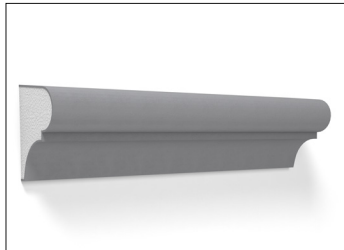

Dimensions:  
90mm(h) x 70mm(w)

## SM-408

Side Profile

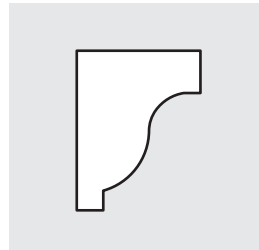

3 Dimensional Visualisation

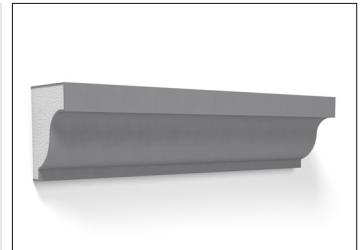

Dimensions:  
90mm(h) x 70mm(w)



## SM-409

Side Profile



3 Dimensional Visualisation

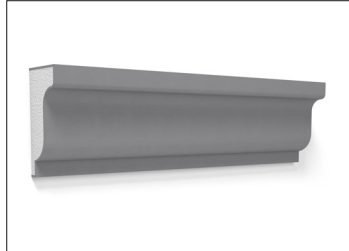

Dimensions:  
100mm(h) x 50mm(w)

## SM-410

Side Profile

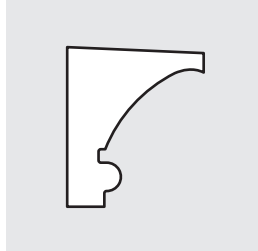

3 Dimensional Visualisation

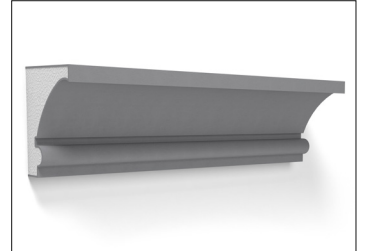

Dimensions:  
105mm(h) x 90mm(w)





# FLAT BANDS

## FB-501

Side Profile

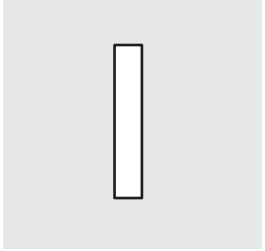

3 Dimensional Visualisation



Dimensions:  
**70mm(h) x 20mm(w)**

## FB-502

Side Profile

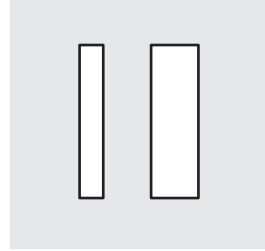

3 Dimensional Visualisation



Dimensions:  
**100mm(h) x 30mm(w); 100mm(h) x 50mm(w)**

## FB-503

Side Profile



3 Dimensional Visualisation



Dimensions:  
**150mm(h) x 30mm(w); 150mm(h) x 40mm(w)**

## FB-504

Side Profile



3 Dimensional Visualisation



Dimensions:  
**200mm(h) x 25mm(w); 200mm(h) x 40mm(w)**

## FB-505

Side Profile



3 Dimensional Visualisation



Dimensions:  
**250mm(h) x 25mm(w)**

## FB-506

Side Profile

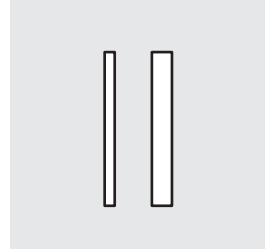

3 Dimensional Visualisation



Dimensions:  
**300mm(h) x 25mm(w); 300mm(h) x 40mm(w)**

## FB-507

Side Profile

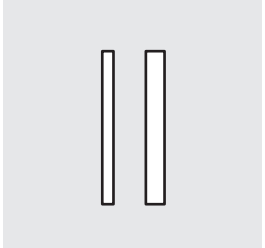

3 Dimensional Visualisation



Dimensions:  
**400mm(h) x 30mm(w); 400mm(h) x 50mm(w)**

## FB-508

Side Profile

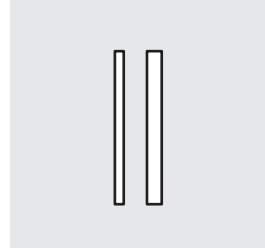

3 Dimensional Visualisation



Dimensions:  
**500mm(h) x 30mm(w); 500mm(h) x 50mm(w)**

## BM-601

Side Profile

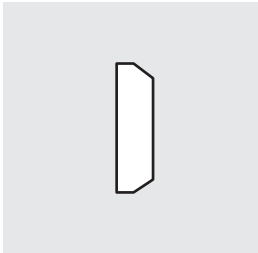

3 Dimensional Visualisation

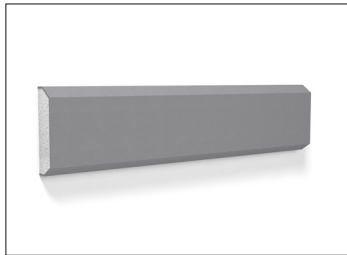

Dimensions:  
**85mm(h) x 25mm(w)**

## BM-602

Side Profile

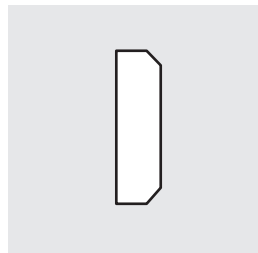

3 Dimensional Visualisation

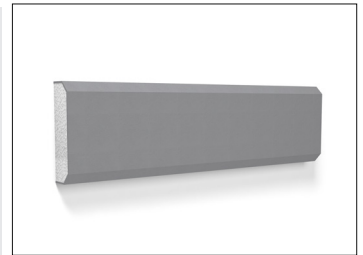

Dimensions:  
**100mm(h) x 30mm(w)**

## BM-603

Side Profile

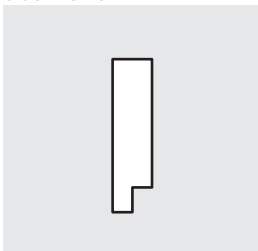

3 Dimensional Visualisation



Dimensions:  
**115mm(h) x 30mm(w)**

## BM-604

Side Profile

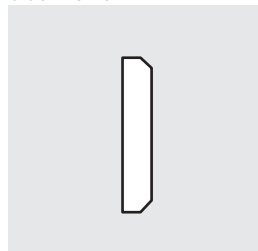

3 Dimensional Visualisation



Dimensions:  
**150mm(h) x 30mm(w)**

## BM-605

Side Profile

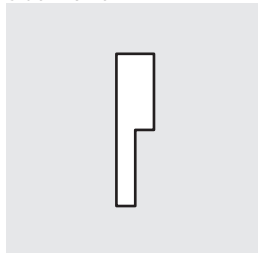

3 Dimensional Visualisation

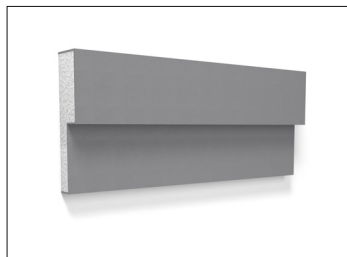

Dimensions:  
**155mm(h) x 40mm(w)**

## BM-606

Side Profile

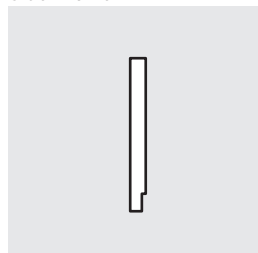

3 Dimensional Visualisation



Dimensions:  
**300mm(h) x 50mm(w)**

## BM-607

Side Profile

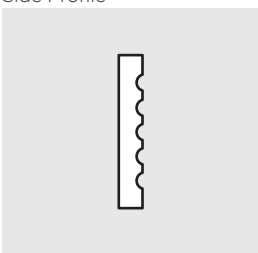

3 Dimensional Visualisation



Dimensions:  
**300mm(h) x 50mm(w)**

## BM-608

Side Profile

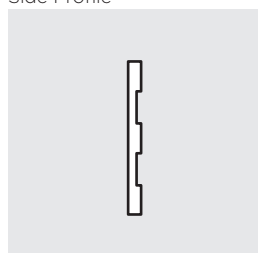

3 Dimensional Visualisation



Dimensions:  
**310mm(h) x 30mm(w)**



## PC-EDWARDIAN

Side Profile

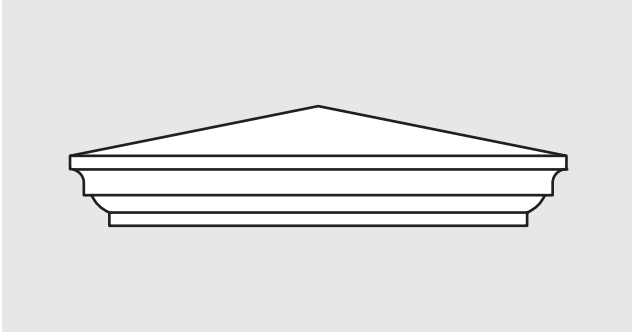

Dimensions:  
**180mm(h) x to suit(w)**

3 Dimensional Visualisation

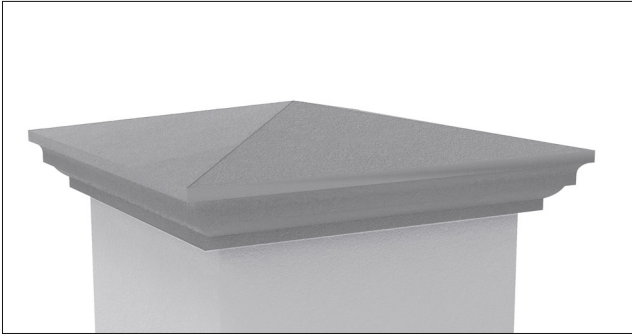

## PC-VICTORIAN

Side Profile

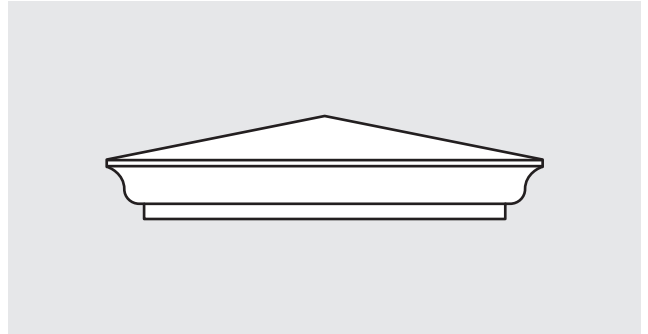

Dimensions:  
**155mm(h) x to suit(w)**

3 Dimensional Visualisation

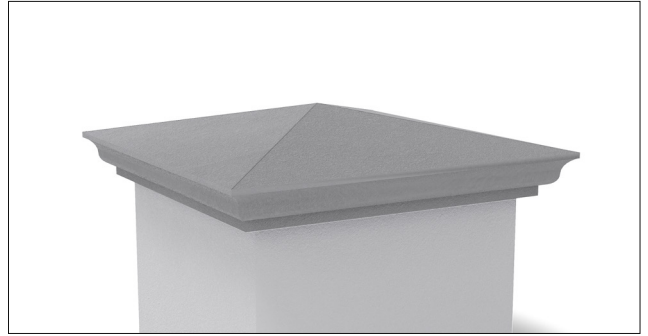

## PC-GEORGIAN

Side Profile

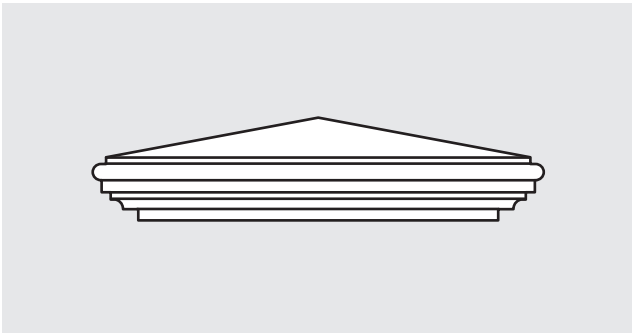

Dimensions:  
**155mm(h) x to suit(w)**

3 Dimensional Visualisation

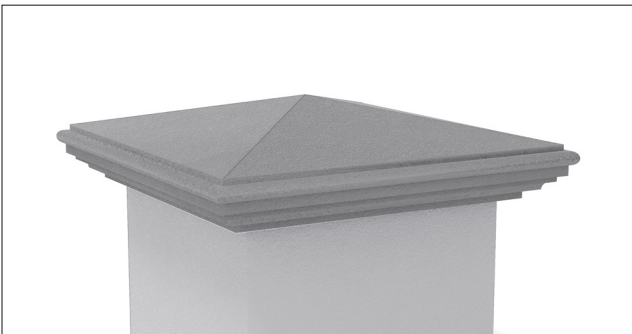

## PC-PLAIN

Side Profile

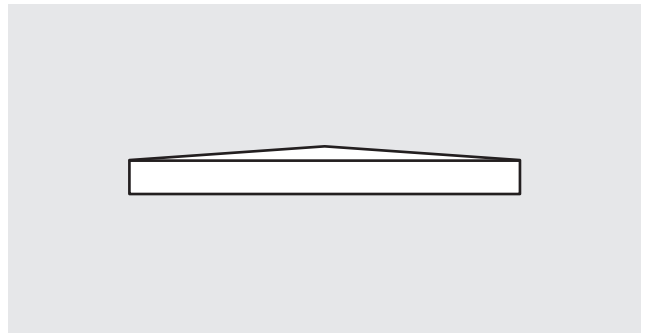

Dimensions:  
**70mm(h) x to suit(w)**

3 Dimensional Visualisation

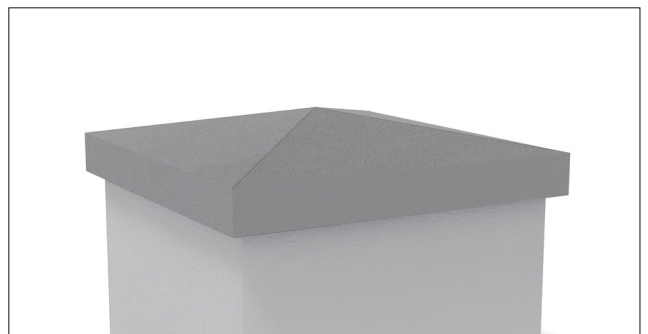

Standard sizes: 1.5 x 1.5 | 1.5 x 2 | 2 x 2 | 2.5 x 2.5 Brick Pier Size



## PC-FRENCH SMALL

Side Profile

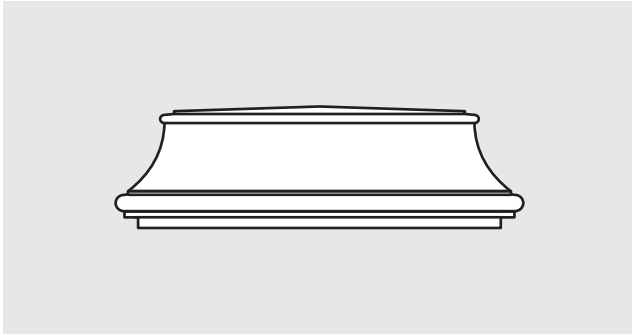

Dimensions:  
**180mm(h) x to suit(w)**

3 Dimensional Visualisation

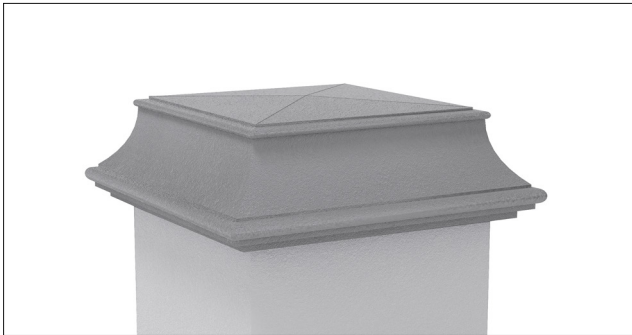

## PC-FRENCH LARGE

Side Profile

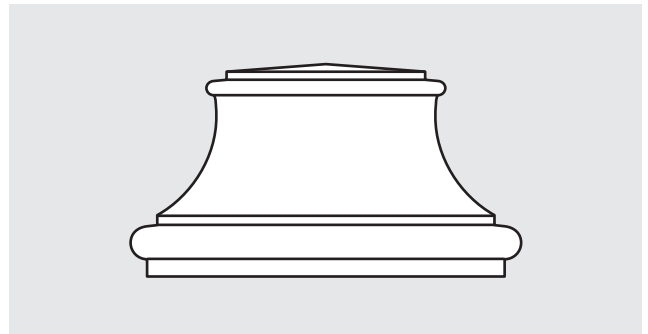

Dimensions:  
**320mm(h) x to suit(w)**

3 Dimensional Visualisation



## PC-FM180

Side Profile

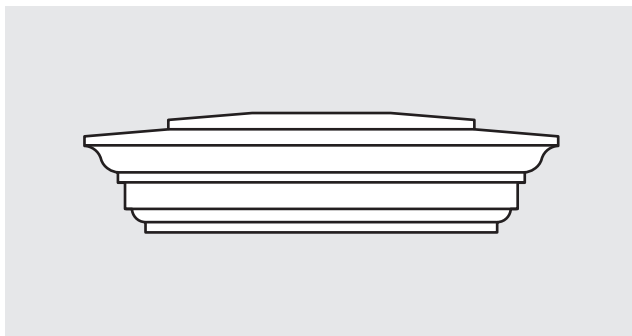

Dimensions:  
**180mm(h) x to suit(w)**

3 Dimensional Visualisation

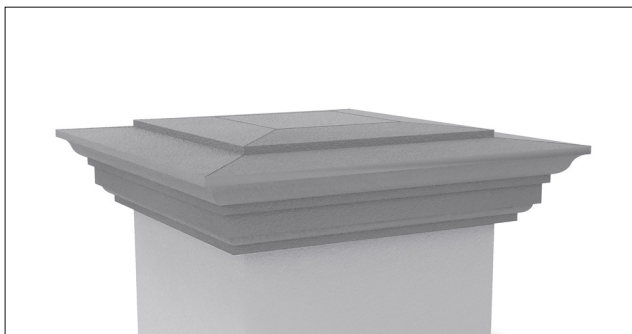

## PC-FM250

Side Profile

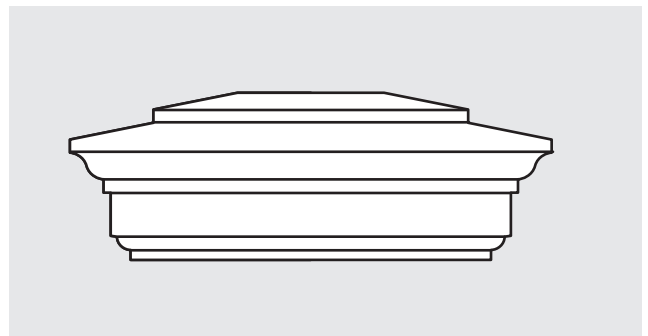

Dimensions:  
**250mm(h) x to suit(w)**

3 Dimensional Visualisation



Standard sizes: 1.5 x 1.5 | 1.5 x 2 | 2 x 2 | 2.5 x 2.5 Brick Pier Size





# QUOINS

## DQ-BASE400

Side Profile

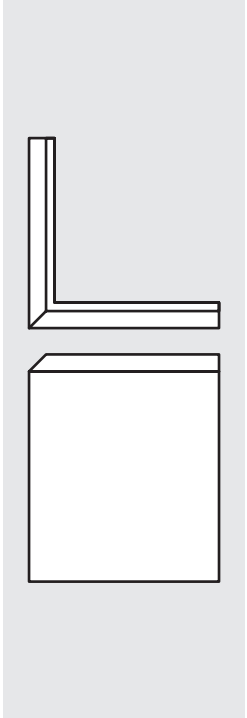

3 Dimensional Visualisation

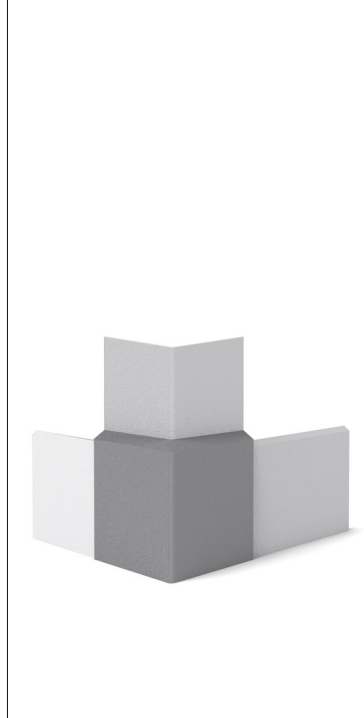

Dimensions:  
400mm(h) x 335mm(w)

## DQ-QO135 L&R

Side Profile

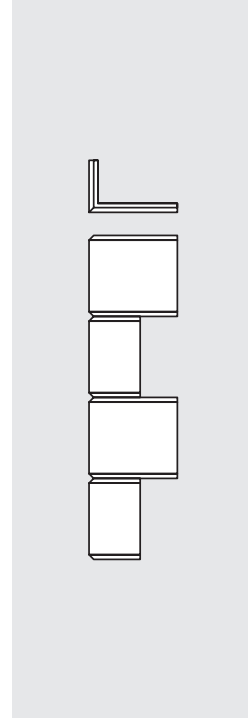

3 Dimensional Visualisation

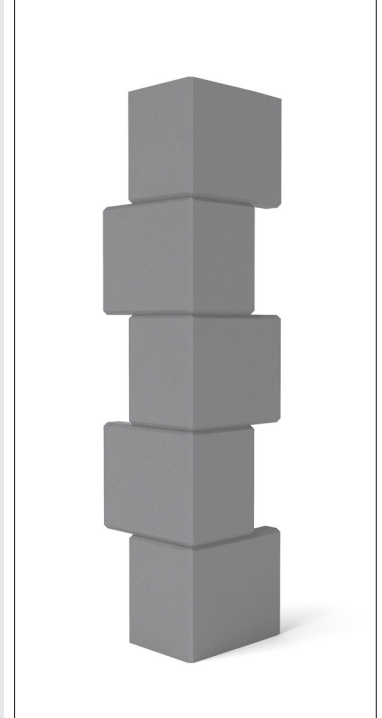

Dimensions:  
1370mm(h) x 380mm(w)

## DQ-QSq270

Side Profile

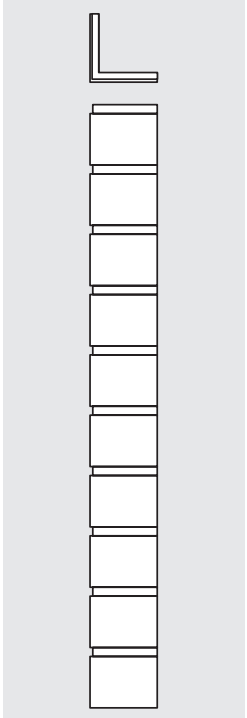

3 Dimensional Visualisation

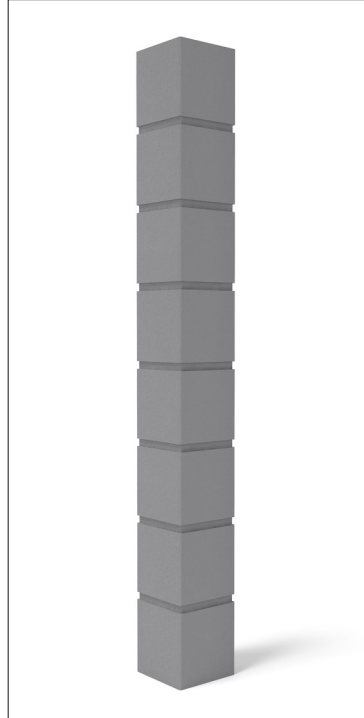

Dimensions:  
2700mm(h) x 305mm(w)

## DQ-QV270 V SLOT

Side Profile

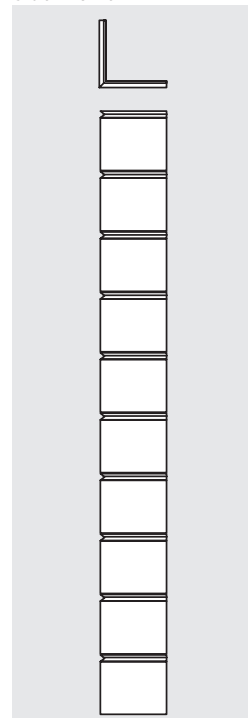

3 Dimensional Visualisation

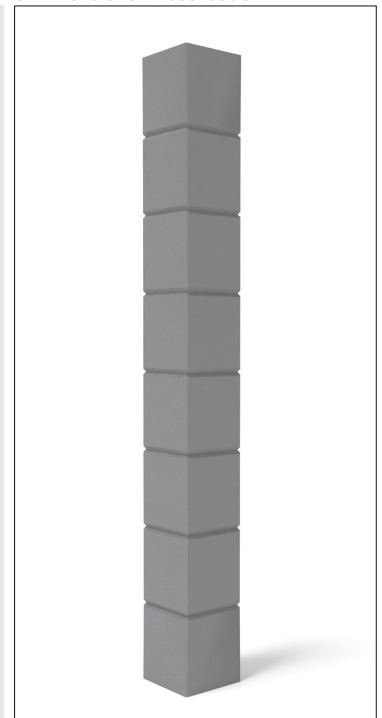

Dimensions:  
2700mm(h) x 305mm(w)

0410 437 702  
(03) 8597 5496  
15 Drake Street  
Sunshine North, 3020  
[www.provincialcladding.com.au](http://www.provincialcladding.com.au)